

Chapter 1

INTRODUCTION TO DIGITAL SIGNAL PROCESSING

1.6 Analog Filters

1.7 Applications of Analog Filters

Copyright © 2018 Andreas Antoniou
Victoria, BC, Canada
Email: aantoniou@ieee.org

July 9, 2018

Introduction

- ▶ Filtering has found widespread applications in many areas such as communications systems, audio systems, speech synthesis, and many other areas.

Introduction

- ▶ Filtering has found widespread applications in many areas such as communications systems, audio systems, speech synthesis, and many other areas.
- ▶ It can be carried out by analog or digital means.

Introduction

- ▶ Filtering has found widespread applications in many areas such as communications systems, audio systems, speech synthesis, and many other areas.
- ▶ It can be carried out by analog or digital means.
- ▶ Analog filters have been in use since 1915 but with the emergence of digital technologies in the 1960s, they began to be replaced by digital filters in many applications.

Introduction

- ▶ Filtering has found widespread applications in many areas such as communications systems, audio systems, speech synthesis, and many other areas.
- ▶ It can be carried out by analog or digital means.
- ▶ Analog filters have been in use since 1915 but with the emergence of digital technologies in the 1960s, they began to be replaced by digital filters in many applications.
- ▶ This presentation will provide a brief historical background on analog filters and their applications.

Filtering

Filtering can be used to pass one or more desirable bands of frequencies and simultaneously reject one or more undesirable bands.

For example,

- ▶ *lowpass filtering* can be used to pass a band of preferred low frequencies and reject a band of undesirable high frequencies

Filtering

Filtering can be used to pass one or more desirable bands of frequencies and simultaneously reject one or more undesirable bands.

For example,

- ▶ *lowpass filtering* can be used to pass a band of preferred low frequencies and reject a band of undesirable high frequencies
- ▶ *highpass filtering* can be used to pass a band of preferred high frequencies and reject a band of undesirable low frequencies

Filtering

Filtering can be used to pass one or more desirable bands of frequencies and simultaneously reject one or more undesirable bands.

For example,

- ▶ *lowpass filtering* can be used to pass a band of preferred low frequencies and reject a band of undesirable high frequencies
- ▶ *highpass filtering* can be used to pass a band of preferred high frequencies and reject a band of undesirable low frequencies
- ▶ *bandpass filtering* can be used to pass a band of frequencies and reject certain low- and high-frequency bands, or

Filtering

Filtering can be used to pass one or more desirable bands of frequencies and simultaneously reject one or more undesirable bands.

For example,

- ▶ *lowpass filtering* can be used to pass a band of preferred low frequencies and reject a band of undesirable high frequencies
- ▶ *highpass filtering* can be used to pass a band of preferred high frequencies and reject a band of undesirable low frequencies
- ▶ *bandpass filtering* can be used to pass a band of frequencies and reject certain low- and high-frequency bands, or
- ▶ *bandstop filtering* can be used to reject a band of frequencies but pass certain low- and high-frequency bands.

- ▶ To illustrate the filtering process consider an arbitrary periodic signal which is made up of a sum of sinusoidal components such as

$$x(t) = \sum_{i=1}^9 A_i \sin(\omega_i t + \theta_i)$$

where A_i is the amplitude and θ_i is the phase angle of the i th sinusoidal component.

- ▶ To illustrate the filtering process consider an arbitrary periodic signal which is made up of a sum of sinusoidal components such as

$$x(t) = \sum_{i=1}^9 A_i \sin(\omega_i t + \theta_i)$$

where A_i is the amplitude and θ_i is the phase angle of the i th sinusoidal component.

- ▶ Arbitrary amplitudes and phase angles can be assigned to the various sinusoidal components as shown in the next slide.

i	ω_i	A_i	θ_i
1	1	0.6154	0.0579
2	2	0.7919	0.3529
3	3	0.9218	-0.8132
4	4	0.7382	0.0099
5	5	0.1763	0.1389
6	6	0.4057	-0.2028
7	7	0.9355	0.1987
8	8	0.9169	-0.6038
9	9	0.4103	-0.2722

Time-domain representation:

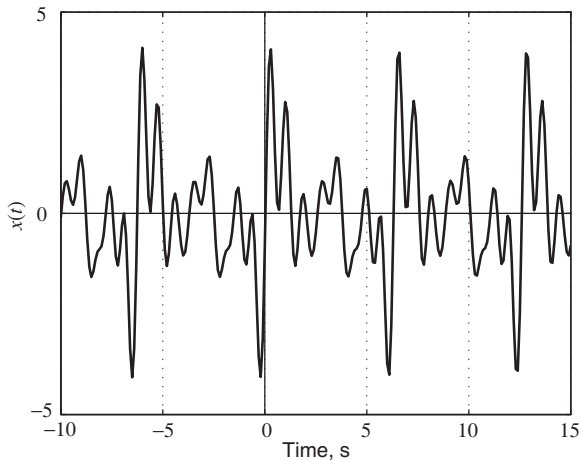

Frequency-domain representation:

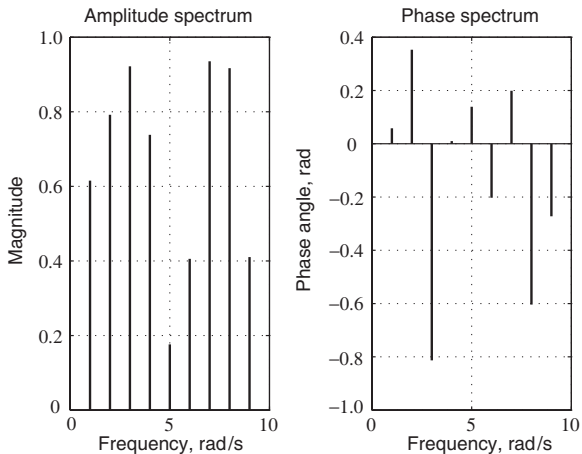

Filtering *Cont'd*

The filtering process can be represented by a block diagram as shown in the figure where $x(t)$ is the input and $y(t)$ is the output of the filtering process.

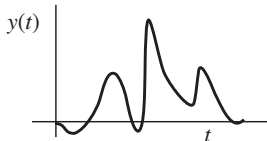
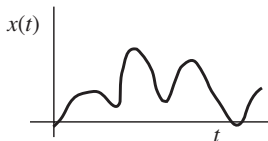

Lowpass Filtering

Lowpass filtering will pass low frequencies and reject high frequencies as shown in the next two slides.

Lowpass Filtering *Cont'd*

Input

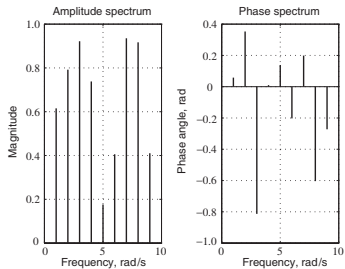

Output

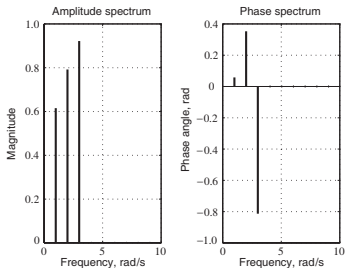

Lowpass Filtering *Cont'd*

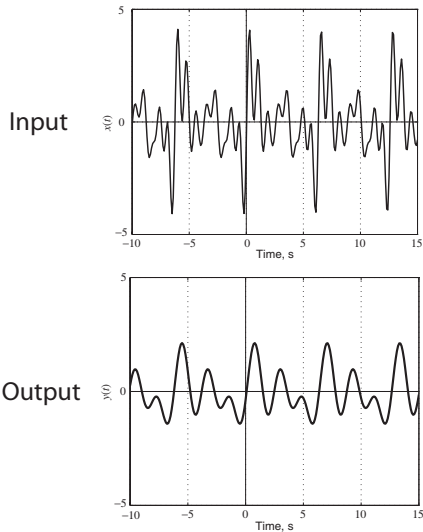

Highpass Filtering

Highpass filtering will pass high frequencies and reject low frequencies as shown in the next two slides.

Highpass Filtering *Cont'd*

Input

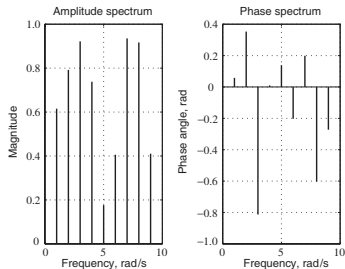

Output

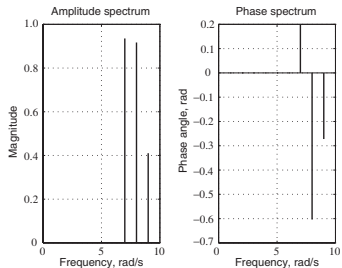

Highpass Filtering *Cont'd*

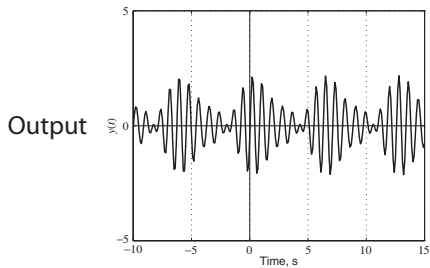
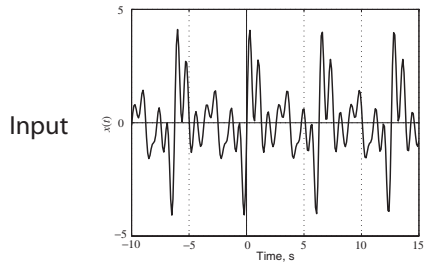

Bandpass Filtering

Input

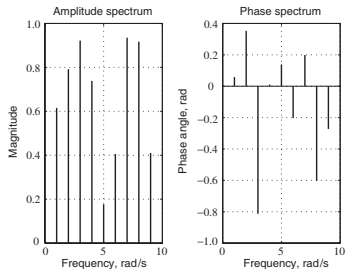

Output

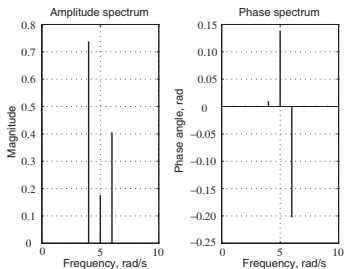

Bandstop Filtering

Input

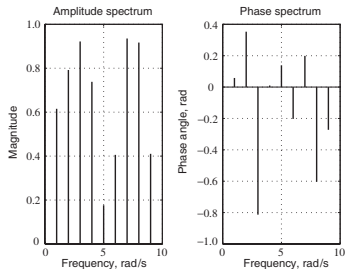

Output

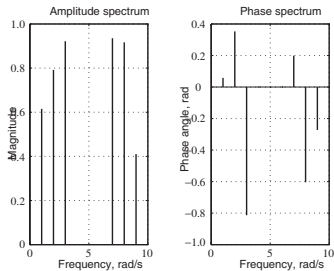

- ▶ In the first presentation, the filtering process was described as a process that will manipulate the spectrum of a signal in some way.

- ▶ In the first presentation, the filtering process was described as a process that will manipulate the spectrum of a signal in some way.
- ▶ In this fairly broad definition, several other filtering processes can be identified such as
 - Differentiation
 - Integration

Differentiation

If we differentiate the signal

$$x(t) = \sum_{i=1}^9 A_i \sin(\omega_i t + \theta_i)$$

with respect to t , we get

$$\begin{aligned} \frac{dx(t)}{dt} &= \sum_{i=1}^9 \frac{d}{dt} [A_i \sin(\omega_i t + \theta_i)] = \sum_{i=1}^9 \omega_i A_i \cos(\omega_i t + \theta_i) \\ &= \sum_{i=1}^9 \omega_i A_i \sin(\omega_i t + \theta_i - \frac{1}{2}\pi) \end{aligned}$$

If we differentiate the signal

$$x(t) = \sum_{i=1}^9 A_i \sin(\omega_i t + \theta_i)$$

with respect to t , we get

$$\begin{aligned} \frac{dx(t)}{dt} &= \sum_{i=1}^9 \frac{d}{dt} [A_i \sin(\omega_i t + \theta_i)] = \sum_{i=1}^9 \omega_i A_i \cos(\omega_i t + \theta_i) \\ &= \sum_{i=1}^9 \omega_i A_i \sin(\omega_i t + \theta_i - \frac{1}{2}\pi) \end{aligned}$$

We note that the amplitude and phase spectrums of the signal have become

$$\{\omega_i A_i : i = 1, 2, \dots, 9\} \quad \text{and} \quad \{\theta_i - \frac{1}{2}\pi : i = 1, 2, \dots, 9\}$$

respectively.

...

$$\{\omega_i A_i : i = 1, 2, \dots, 9\} \quad \text{and} \quad \{\theta_i - \frac{1}{2}\pi : i = 1, 2, \dots, 9\}$$

In effect,

- ▶ the amplitude spectrum has been multiplied by the frequency ω_i , and

...

$$\{\omega_i A_i : i = 1, 2, \dots, 9\} \quad \text{and} \quad \{\theta_i - \frac{1}{2}\pi : i = 1, 2, \dots, 9\}$$

In effect,

- ▶ the amplitude spectrum has been multiplied by the frequency ω_i , and
- ▶ an angle of $\pi/2$ has been subtracted from the phase spectrum.

Input

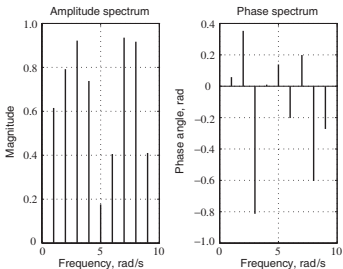

Output

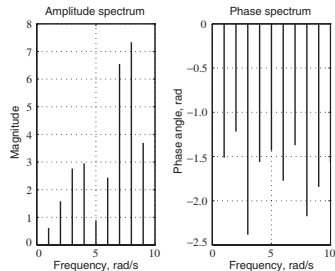

Input

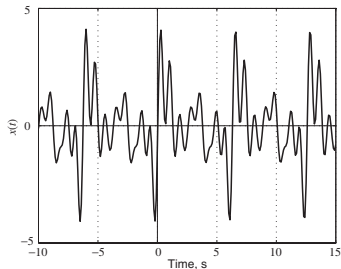

Output

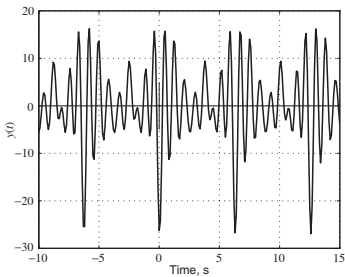

Differentiation *Cont'd*

Evidently, differentiation tends to enhance high-frequency components and weaken low-frequency components somewhat like highpass filtering.

Integration

If we integrate the signal

$$x(t) = \sum_{i=1}^9 A_i \sin(\omega_i t + \theta_i)$$

with respect to t , we get

$$\begin{aligned} \int x(t) dt &= \sum_{i=1}^9 \int A_i \sin(\omega_i t + \theta_i) dt = \sum_{i=1}^9 \left[-\frac{A_i}{\omega_i} \cos(\omega_i t + \theta_i) \right] \\ &= \sum_{i=1}^9 \frac{A_i}{\omega_i} \sin(\omega_i t + \theta_i - \frac{1}{2}\pi) \end{aligned}$$

Integration

If we integrate the signal

$$x(t) = \sum_{i=1}^9 A_i \sin(\omega_i t + \theta_i)$$

with respect to t , we get

$$\begin{aligned} \int x(t) dt &= \sum_{i=1}^9 \int A_i \sin(\omega_i t + \theta_i) dt = \sum_{i=1}^9 \left[-\frac{A_i}{\omega_i} \cos(\omega_i t + \theta_i) \right] \\ &= \sum_{i=1}^9 \frac{A_i}{\omega_i} \sin(\omega_i t + \theta_i - \frac{1}{2}\pi) \end{aligned}$$

The amplitude and phase spectrums of the signal have become

$$\{A_i/\omega_i : i = 1, 2, \dots, 9\} \quad \text{and} \quad \{\theta_i - \frac{1}{2}\pi : i = 1, 2, \dots, 9\}$$

respectively.

...

$$\{A_i/\omega_i : i = 1, 2, \dots, 9\} \quad \text{and} \quad \{\theta_i - \frac{1}{2}\pi : i = 1, 2, \dots, 9\}$$

Evidently,

- ▶ the amplitude spectrum has been divided by the frequency ω_i , and

...

$$\{A_i/\omega_i : i = 1, 2, \dots, 9\} \quad \text{and} \quad \{\theta_i - \frac{1}{2}\pi : i = 1, 2, \dots, 9\}$$

Evidently,

- ▶ the amplitude spectrum has been divided by the frequency ω_i , and
- ▶ an angle of $\pi/2$ has been subtracted from the phase spectrum.

Input

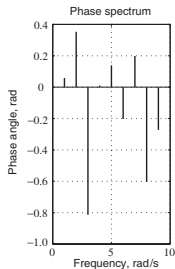
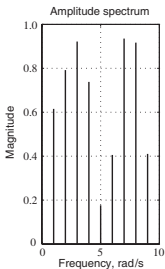

Output

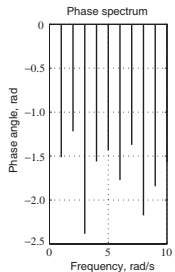
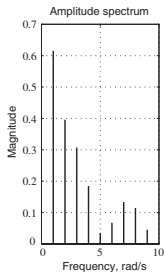

Integration *Cont'd*

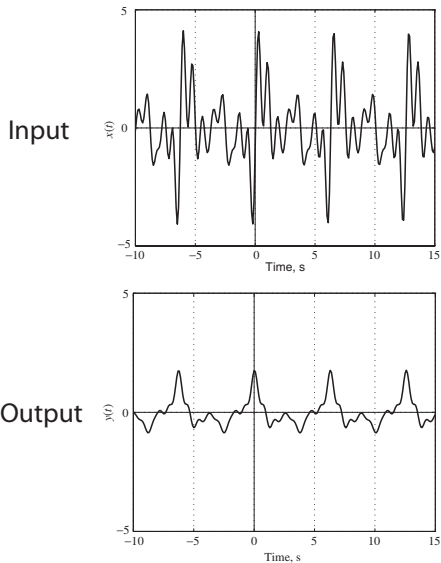

Integration *Cont'd*

Evidently, integration tends to enhance low-frequency components and weaken high-frequency components somewhat like lowpass filtering.

Electrical Filters

- ▲ Electrical engineers have known about filtering processes for well over 80 years and through the years they invented a great variety of circuits and systems that can perform filtering, which are known collectively as *filters*.

Electrical Filters

- ▲ Electrical engineers have known about filtering processes for well over 80 years and through the years they invented a great variety of circuits and systems that can perform filtering, which are known collectively as *filters*.
- ▲ Electrical filters can be classified on the basis of their operating signals as *analog* or *digital*.

Electrical Filters

- ▲ Electrical engineers have known about filtering processes for well over 80 years and through the years they invented a great variety of circuits and systems that can perform filtering, which are known collectively as *filters*.
- ▲ Electrical filters can be classified on the basis of their operating signals as *analog* or *digital*.
- ▲ In analog filters the input, output, and internal signals are in the form of continuous-time signals whereas in digital filters they are in the form of discrete-time signals.

Analog Filters

- ▲ Analog filters were originally invented for use in radio receivers and long-distance telephone systems and continue to be critical components in all types of communication systems.

Analog Filters

- ▲ Analog filters were originally invented for use in radio receivers and long-distance telephone systems and continue to be critical components in all types of communication systems.
- ▲ Various families of analog filters have evolved over the years, which can be classified as follows on the basis of their constituent elements and the technology used:
 - Passive RLC filters
 - Discrete active RC filters
 - Integrated active RC filters
 - Switched-capacitor filters
 - Microwave filters

Passive *RLC* Filters

- ▲ *Passive RLC filters* began to be used extensively in the early twenties.

Passive *RLC* Filters

- ▲ *Passive RLC filters* began to be used extensively in the early twenties.
- ▲ They are made of interconnected *resistors, inductors, and capacitors* and are said to be *passive* in view of the fact that they do not require an energy source, like a power supply, to operate.

Passive *RLC* Filters

- ▲ *Passive RLC filters* began to be used extensively in the early twenties.
- ▲ They are made of interconnected *resistors, inductors, and capacitors* and are said to be *passive* in view of the fact that they do not require an energy source, like a power supply, to operate.
- ▲ Filtering action is achieved through the property of *electrical resonance* which occurs when an inductor and a capacitor are connected in series or in parallel.

Passive *RLC* Filters

- ▲ *Passive RLC filters* began to be used extensively in the early twenties.
- ▲ They are made of interconnected *resistors, inductors, and capacitors* and are said to be *passive* in view of the fact that they do not require an energy source, like a power supply, to operate.
- ▲ Filtering action is achieved through the property of *electrical resonance* which occurs when an inductor and a capacitor are connected in series or in parallel.
- ▲ The importance of filtering in communications motivated engineers and mathematicians between the thirties and fifties to develop some very powerful and sophisticated methods for the design of passive *RLC* filters.

Passive *RLC* Filters *Cont'd*

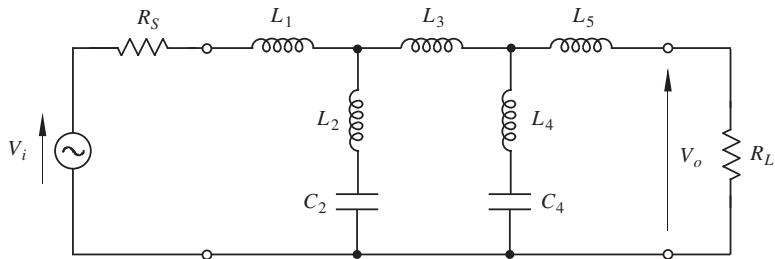

Passive *RLC* lowpass filter

Discrete Active RC Filters

- ▲ *Discrete active RC filters* began to appear during the mid-fifties and were a hot topic of research during the sixties.

Discrete Active RC Filters

- ▲ *Discrete active RC filters* began to appear during the mid-fifties and were a hot topic of research during the sixties.
- ▲ They are made up of discrete *resistors, capacitors, and amplifying electronic circuits.*

Discrete Active RC Filters

- ▲ *Discrete active RC filters* began to appear during the mid-fifties and were a hot topic of research during the sixties.
- ▲ They are made up of discrete *resistors, capacitors, and amplifying electronic circuits*.
- ▲ *Inductors are absent* and it is this feature that makes active RC filters attractive.

Discrete Active *RC* Filters *Cont'd*

- ▲ Inductors have always been bulky, expensive, and generally less ideal than resistors and capacitors particularly for low-frequency applications.

Discrete Active *RC* Filters *Cont'd*

- ▲ Inductors have always been bulky, expensive, and generally less ideal than resistors and capacitors particularly for low-frequency applications.
- ▲ Unfortunately, *without inductors electrical resonance cannot be achieved* and with just resistors and capacitors only crude types of filters can be designed.

- ▲ Inductors have always been bulky, expensive, and generally less ideal than resistors and capacitors particularly for low-frequency applications.
- ▲ Unfortunately, *without inductors electrical resonance cannot be achieved* and with just resistors and capacitors only crude types of filters can be designed.
- ▲ However, *through the clever use of amplifying electronic circuits in RC circuits, it is possible to simulate resonance-like effects* that can be utilized to achieve filtering of high quality.

- ▲ Inductors have always been bulky, expensive, and generally less ideal than resistors and capacitors particularly for low-frequency applications.
- ▲ Unfortunately, *without inductors electrical resonance cannot be achieved* and with just resistors and capacitors only crude types of filters can be designed.
- ▲ However, *through the clever use of amplifying electronic circuits in RC circuits, it is possible to simulate resonance-like effects* that can be utilized to achieve filtering of high quality.
- ▲ These filters are said to be *active* because the amplifying electronic circuits require an energy source in the form of a power supply.

Discrete Active RC Filters *Cont'd*

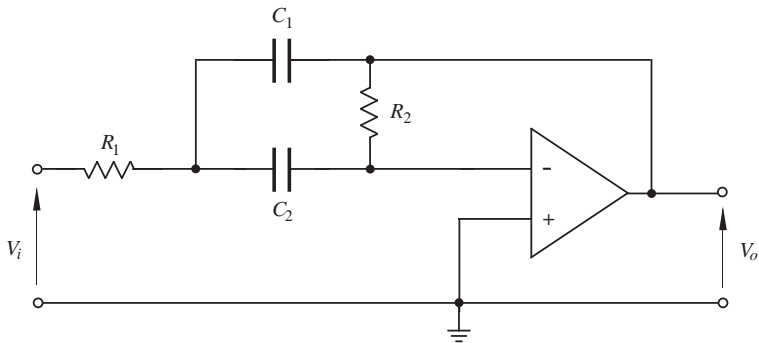

Discrete active bandpass filter

Integrated-Circuit Active RC Filters

- ▲ *Integrated-circuit active RC filters* operate on the basis of the same principles as their discrete counterparts except that they *are designed directly as complete integrated circuits*.

Integrated-Circuit Active RC Filters

- ▲ *Integrated-circuit active RC filters* operate on the basis of the same principles as their discrete counterparts except that they *are designed directly as complete integrated circuits*.
- ▲ Through the use of high-frequency amplifying circuits and suitable integrated-circuit elements, filters can be designed that can operate at frequencies as high as 15 GHz.

Integrated-Circuit Active RC Filters

- ▲ *Integrated-circuit active RC filters* operate on the basis of the same principles as their discrete counterparts except that they *are designed directly as complete integrated circuits*.
- ▲ Through the use of high-frequency amplifying circuits and suitable integrated-circuit elements, filters can be designed that can operate at frequencies as high as 15 GHz.
- ▲ Interest in these filters has been strong during the eighties and nineties and research is continuing.

Switched-Capacitor Filters

- ▲ *Switched-capacitor filters* evolved during the seventies and eighties.

Switched-Capacitor Filters

- ▲ *Switched-capacitor filters* evolved during the seventies and eighties.
- ▲ These are essentially active RC filters except that switches are also utilized along with amplifying devices.

Switched-Capacitor Filters

- ▲ *Switched-capacitor filters* evolved during the seventies and eighties.
- ▲ These are essentially active RC filters except that switches are also utilized along with amplifying devices.
- ▲ In this family of filters, *switches are used to simulate high resistance values which are difficult to implement in integrated-circuit form.*

Switched-Capacitor Filters

- ▲ *Switched-capacitor filters* evolved during the seventies and eighties.
- ▲ These are essentially active RC filters except that switches are also utilized along with amplifying devices.
- ▲ In this family of filters, *switches are used to simulate high resistance values which are difficult to implement in integrated-circuit form.*
- ▲ Like integrated active RC filters, switched-capacitor filters are compatible with integrated-circuit technology.

Microwave Filters

- ▲ At microwave frequencies *in the range 0.5 to 500 GHz*, *inductors and transistors do not work very well* and, therefore, passive *RLC* or active *RC* filters have poor performance; hence, *microwave filters* are used.

Microwave Filters

- ▲ At microwave frequencies *in the range 0.5 to 500 GHz*, *inductors and transistors do not work very well* and, therefore, passive *RLC* or active *RC* filters have poor performance; hence, *microwave filters* are used.
- ▲ Microwave filters are built from a variety of microwave components and devices such as waveguides, dielectric resonators, and surface acoustic devices.

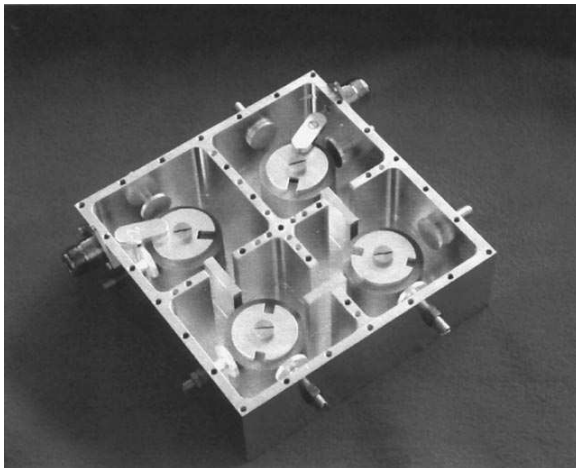

Microwave bandpass filter

Applications of Analog Filters

▲ Radios and TVs

Applications of Analog Filters

- ▲ Radios and TVs
- ▲ Communication and radar systems

Applications of Analog Filters

- ▲ Radios and TVs
- ▲ Communication and radar systems
- ▲ Telephone systems

Applications of Analog Filters

- ▲ Radios and TVs
- ▲ Communication and radar systems
- ▲ Telephone systems
- ▲ Sampling systems

Applications of Analog Filters

- ▲ Radios and TVs
- ▲ Communication and radar systems
- ▲ Telephone systems
- ▲ Sampling systems
- ▲ Audio equipment

Applications of Analog Filters *Cont'd*

- ▲ When we select our favorite radio station or TV channel, we are actually tuning a bandpass filter inside the radio or TV to the frequencies of the radio or TV station.

The signal from our favorite radio station is the desirable signal and the signals from all the other stations are undesirable.

Applications of Analog Filters *Cont'd*

- ▲ When we select our favorite radio station or TV channel, we are actually tuning a bandpass filter inside the radio or TV to the frequencies of the radio or TV station.

The signal from our favorite radio station is the desirable signal and the signals from all the other stations are undesirable.

- ▲ The same principle can be used to prevent radar signals from interfering with communications channels and vice-versa at an airport.

Applications of Analog Filters *Cont'd*

- ▲ Signals are often corrupted by spurious signals known collectively as *noise*.

Such signals may originate from a large number of sources, e.g., lightnings, electrical motors, transformers, and power lines.

Noise signals are characterized by frequency spectrums that stretch over a wide range of frequencies. They can be eliminated through the use of bandpass filters that would pass the desired signal but reject everything else, namely, the noise content.

Applications of Analog Filters *Cont'd*

- ▲ We all talk to our friends and relatives, who may live in another city or another country, almost daily through the telephone system. The telephone signals are transmitted through expensive communications channels.

If these channels were to carry just a single voice, as in the days of Alexander Graham Bell, no one would ever be able to afford a telephone call to anyone, even the very rich.

Frequency-Division Multiplex System

- ▲ What makes long-distance calls affordable is our ability to transmit thousands upon thousands of conversations through one and the same communications channel.

Frequency-Division Multiplex System

- ▲ What makes long-distance calls affordable is our ability to transmit thousands upon thousands of conversations through one and the same communications channel.
- ▲ This is achieved through the use of a so-called *frequency-division multiplex (FDM) communications system*.

Frequency-Division Multiplex System

- ▲ What makes long-distance calls affordable is our ability to transmit thousands upon thousands of conversations through one and the same communications channel.
- ▲ This is achieved through the use of a so-called *frequency-division multiplex (FDM) communications system*.
- ▲ An FDM communication system requires a multitude of filters to operate properly.

Frequency-Division Multiplex System *Cont'd*

The operation of a typical FDM communications system is as follows:

1. At the transmit end, the different voice signals are superimposed on different carrier frequencies using a process known as modulation.
2. The different carrier frequencies are combined by using an adder circuit.
3. At the receive end, carrier frequencies are separated using bandpass filters.
4. The voice signals are then extracted from the carrier frequencies through demodulation.
5. The voice signals are distributed to the appropriate persons through the local telephone lines.

Frequency-Division Multiplex System *Cont'd*

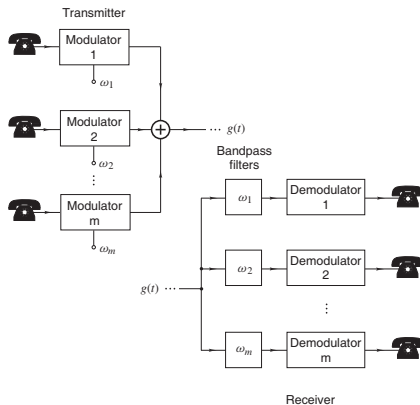

(a) Basic FDM system

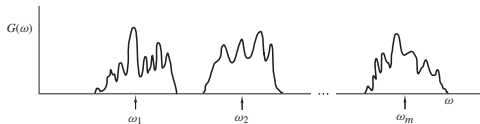

(b) Voice signals arranged into a group

Frequency-Division Multiplex System *Cont'd*

- ▲ The transmit section adds the frequency of a unique carrier to the frequencies of each voice signal, thereby, shifting its frequency spectrum by the frequency of the carrier.

In this way, the frequency spectrums of the different voice signals are arranged one after the other to form the composite signal $g(t)$ shown in figure (a) of the previous slide, which is referred to as a *group* by telephone engineers.

The amplitude spectrum of $g(t)$, designated as $G(\omega)$, is illustrated in Fig. (b).

Frequency-Division Multiplex System *Cont'd*

- ▲ The receive section separates the translated voice signals and restores their original spectrums.

Frequency-Division Multiplex System *Cont'd*

- ▲ The receive section separates the translated voice signals and restores their original spectrums.
- ▲ The FDM system requires as many bandpass filters as there are voice signals, and this is why thousands upon thousands of bandpass filters are required.

Frequency-Division Multiplex System *Cont'd*

- ▲ The receive section separates the translated voice signals and restores their original spectrums.
- ▲ The FDM system requires as many bandpass filters as there are voice signals, and this is why thousands upon thousands of bandpass filters are required.
- ▲ The FDM system also uses a large number of modulators and demodulators and these devices, as it turns out, also need filters to operate properly.

Frequency-Division Multiplex System *Cont'd*

- ▲ The receive section separates the translated voice signals and restores their original spectrums.
- ▲ The FDM system requires as many bandpass filters as there are voice signals, and this is why thousands upon thousands of bandpass filters are required.
- ▲ The FDM system also uses a large number of modulators and demodulators and these devices, as it turns out, also need filters to operate properly.
- ▲ In short, *communications systems are simply not feasible without filters.*

Frequency-Division Multiplex System *Cont'd*

- ▲ A more complex FDM system can be constructed by modulating several groups individually as if they were voice signals and then adding them up to form a *supergroup* to increase the number of voice signals transmitted over an intercity cable or microwave link.

Frequency-Division Multiplex System *Cont'd*

- ▲ A more complex FDM system can be constructed by modulating several groups individually as if they were voice signals and then adding them up to form a *supergroup* to increase the number of voice signals transmitted over an intercity cable or microwave link.
- ▲ At the receiving end, a supergroup is subdivided into the individual groups by a bank of bandpass filters. The groups are, in turn, subdivided into the individual voice signals by appropriate banks of bandpass filters.

Frequency-Division Multiplex System *Cont'd*

- ▲ A more complex FDM system can be constructed by modulating several groups individually as if they were voice signals and then adding them up to form a *supergroup* to increase the number of voice signals transmitted over an intercity cable or microwave link.
- ▲ At the receiving end, a supergroup is subdivided into the individual groups by a bank of bandpass filters. The groups are, in turn, subdivided into the individual voice signals by appropriate banks of bandpass filters.
- ▲ Similarly, several supergroups can be combined into a *mastergroup*, and so on, until the bandwidth capacity of the cable or microwave link is completely filled.

Frequency-Division Multiplex System *Cont'd*

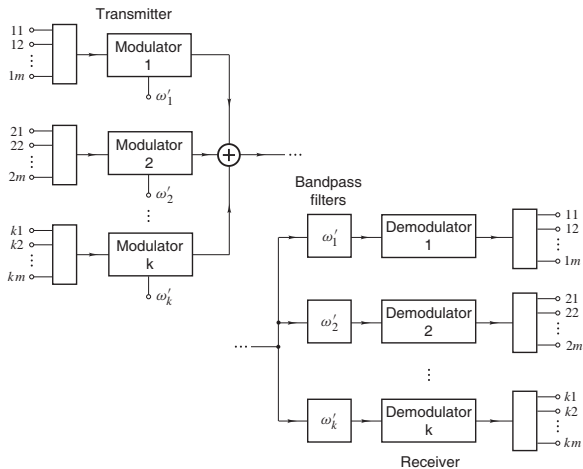

FDM system with two levels of modulation.

Use of Analog Filters in Sampling Systems

- ▲ In a sampling system, the sampling frequency must be at least twice the highest frequency present in the spectrum of the signal. This is known as the *sampling theorem*.

Use of Analog Filters in Sampling Systems

- ▲ In a sampling system, the sampling frequency must be at least twice the highest frequency present in the spectrum of the signal. This is known as the *sampling theorem*.
- ▲ In situations where the sampling frequency is fixed and the highest frequency present in the signal can exceed half the sampling frequency, it is crucial to *bandlimit* the signal to be sampled to prevent a certain type of signal distortion known as *aliasing*.

Use of Analog Filters in Sampling Systems

- ▲ In a sampling system, the sampling frequency must be at least twice the highest frequency present in the spectrum of the signal. This is known as the *sampling theorem*.
- ▲ In situations where the sampling frequency is fixed and the highest frequency present in the signal can exceed half the sampling frequency, it is crucial to *bandlimit* the signal to be sampled to prevent a certain type of signal distortion known as *aliasing*.
- ▲ This bandlimiting process, must be carried out through the use of a lowpass analog filter.

Use of Analog Filters in Sampling Systems

- ▲ In a sampling system, the sampling frequency must be at least twice the highest frequency present in the spectrum of the signal. This is known as the *sampling theorem*.
- ▲ In situations where the sampling frequency is fixed and the highest frequency present in the signal can exceed half the sampling frequency, it is crucial to *bandlimit* the signal to be sampled to prevent a certain type of signal distortion known as *aliasing*.
- ▲ This bandlimiting process, must be carried out through the use of a lowpass analog filter.
- ▲ A sampling system also requires an analog lowpass filter at the output of the D/A converter to serve as smoothing device.

Use of Analog Filters in Sampling Systems *Cont'd*

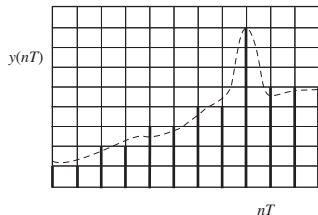
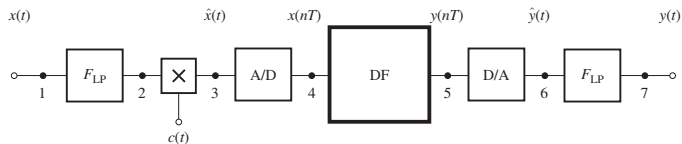

(a)

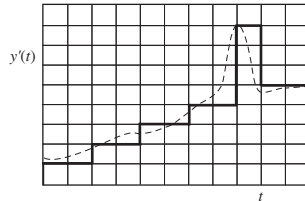

(b)

Use of Analog Filters as Equalizers

- ▲ Loudspeaker systems behave very much like filters and, consequently, they tend to change the spectrum of an audio signal.

Use of Analog Filters as Equalizers

- ▲ Loudspeaker systems behave very much like filters and, consequently, they tend to change the spectrum of an audio signal.
- ▲ This is due to the fact that the enclosure or cabinet used can often exhibit mechanical resonances that are superimposed on the audio signal.

Use of Analog Filters as Equalizers

- ▲ Loudspeaker systems behave very much like filters and, consequently, they tend to change the spectrum of an audio signal.
- ▲ This is due to the fact that the enclosure or cabinet used can often exhibit mechanical resonances that are superimposed on the audio signal.
- ▲ This is one of the reasons why different makes of loudspeaker systems often produce their own characteristic sound.

Use of Analog Filters as Equalizers *Cont'd*

- ▲ To correct for mechanical resonances and other imperfections, sound reproduction equipment, such as stereos, is often equipped with *equalizers* that can be used to reshape the spectrum of the audio signal.

These subsystems typically incorporate a number of sliders that can be adjusted to modify the quality of the sound reproduced.

One can, for example, strengthen or weaken the low-frequency (bass) or high-frequency (treble) content of the audio signal.

Use of Analog Filters as Equalizers *Cont'd*

- ▲ Since an equalizer is a device that can modify the spectrum of a signal, *equalizers are filters* in terms of the broader definition adopted in the textbook.

What the sliders do is to alter the parameters of the filter that performs the equalization.

Use of Analog Filters as Equalizers *Cont'd*

- ▲ Since an equalizer is a device that can modify the spectrum of a signal, *equalizers are filters* in terms of the broader definition adopted in the textbook.

What the sliders do is to alter the parameters of the filter that performs the equalization.

- ▲ Through the use of an equalizer, one could adjust the spectrum of the audio signal to one's preference.

- ▲ Since an equalizer is a device that can modify the spectrum of a signal, *equalizers are filters* in terms of the broader definition adopted in the textbook.

What the sliders do is to alter the parameters of the filter that performs the equalization.

- ▲ Through the use of an equalizer, one could adjust the spectrum of the audio signal to one's preference.
- ▲ A thick carpet can actually absorb a lot of the high-frequency content of the audio signal, i.e., the room would behave very much like a lowpass filter.

In such a situation, one might need to boost the treble a bit to restore some of the lost high-frequency content of the music.

Use of Analog Filters as Equalizers *Cont'd*

- ▲ Transmission cables, telephone lines, and communication channels often behave very much like filters and, as a result, they tend to reshape the spectrums of the signals transmitted through them.

The local telephone lines are particularly notorious in this respect – we often do not even recognize the voice of the person at the other end only because the spectrum of the signal has been changed by the telephone line.

Use of Analog Filters as Equalizers *Cont'd*

- ▲ Like the performance of loudspeaker systems, that of telephone lines and communication channels can be improved by using suitable equalizers.

In fact, it is through the use of sophisticated equalizers, in the form of *adaptive filters*, that it is possible to achieve high data transmission rates through local telephone lines.

Use of Analog Filters as Equalizers *Cont'd*

- ▲ Like the performance of loudspeaker systems, that of telephone lines and communication channels can be improved by using suitable equalizers.

In fact, it is through the use of sophisticated equalizers, in the form of *adaptive filters*, that it is possible to achieve high data transmission rates through local telephone lines.

- ▲ These equalizers are incorporated in the modems at either end of a telephone line.

So-called ADSL Internet service available through telephone companies is achieved by means of adaptive filters.

*This slide concludes the presentation.
Thank you for your attention.*